

12AL065 12ALZ065

AMARON QUANTA™

The industrial segment SMF-VRLA (Valve Regulated Lead Acid) battery for UPS applications is built to perform.

In short, the lifeline to your UPS applications

AMARON QUANTA™ is a product of fail- safe, fool-proof battery technology, produced and tested in our premier manufacturing facility. Built to the highest technical competence in its class, the QUANTA is an example of Amara Raja's commitment to bringing the best of technology to your table

It features several firsts for the battery industry like the unique Radgrid™

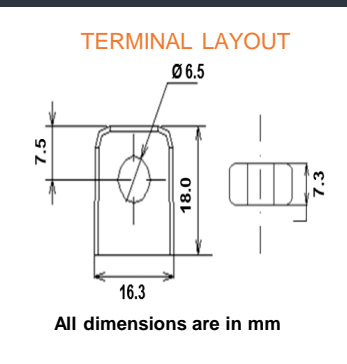

Specification

Nominal Voltage	12V	
Rated Capacity	65Ah / C ₂₀ Hr / 1.75VPC / 27°C	
Dimensions (±2mm)	Length	351 mm (13.82 in.)
	Width	167 mm (6.57 in.)
	Total Height	175 mm (6.89 in.)
Weight (±5%)	19.20 Kg (42.33 lbs)	
Terminal Type	M6 x 20 mm Bolted	
Capacity @ 27°C	55.90 Ah	(10hr, 5.59 A, 10.5 V/battery)
	51.40 Ah	(5hr, 10.29 A, 10.2 V/battery)
	36.30 Ah	(1hr, 36.3 A, 9.6V /battery)
	40°C (104°F)	110%
Capacity affected (Temperature at C20 hr rate)	27°C (80.6°F)	100%
	0°C (32°F)	80%
	-15°C (5°F)	60%
	Standard	PPCP (12AL065)
Case Material	FR Version	
Internal Resistance (IR)	Approx. 9.4 mΩ for a fully charged battery (27°C)	
	Short Circuit Current (As per IEC)	
Short Circuit Current (As per IEC)	1382 A	
Operating Temp. range	-20°C to +60°C (50 to 60°C for shorter duration)	
Nominal Operating Temp. range	27°C ± 3°C	
Standby use (27°C)	Charging Voltage	13.5 V/battery
	Charging Current	Max. 25% of rated capacity
	Temp. Compensation	± 18mV/battery/°C
Cyclic use (27°C)	Charging Voltage	13.8 V/battery
	Charging Current	Max. 25% of rated capacity
	Temp. Compensation	± 30mV/battery/°C
Self-Discharge	< 4% per month at 27°C	

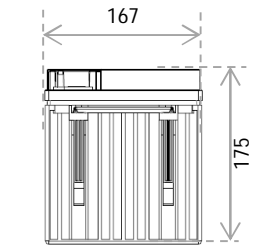
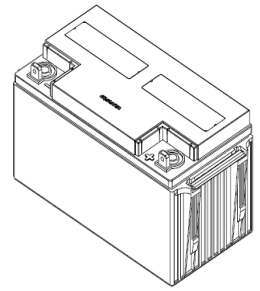

Constant Power Discharge Rating (Watts Per Battery) @ 27°C *

ECV/ Time	10min	15min	20min	30min	60min	2hrs	3hrs	5hrs	8hrs	10hrs	20hrs
1.60	1368	1120	898	682	412	248	172.0	118.0	77.0	67.0	31.0
1.65	1345	1101	887	671	408	245	171.0	117.0	76.5	66.5	30.5
1.70	1322	1081	876	660	403	242	170.0	116.0	76.0	66.0	30.0
1.75	1299	1041	848	640	392	239	169.0	115.0	75.0	65.0	29.5
1.80	1276	1000	820	620	380	236	168.0	114.0	74.0	64.0	29.0

Constant Current Discharge Rating (Amperes) @ 27°C *

ECV/ Time	10min	15min	20 min	30min	60 min	2 hrs	3 hrs	5 hrs	8hrs	10 hrs	20 hrs
1.60	126.47	101.10	80.23	60.87	36.36	22.06	15.07	11.12	6.90	5.83	3.48
1.65	122.62	96.75	77.30	58.44	35.90	21.17	14.62	10.71	6.75	5.76	3.40
1.70	118.77	92.41	74.37	56.00	35.44	20.27	14.16	10.29	6.60	5.69	3.31
1.75	114.29	90.32	73.68	55.45	35.00	20.00	14.14	10.26	6.56	5.59	3.25
1.80	112.00	88.89	71.79	54.90	33.49	19.86	14.07	10.17	6.52	5.56	3.23

Note:

1. The above data are average values per battery and can be obtained within five charge/discharge cycle
2. A tolerance of ±5% is applicable for the above constant power discharge and constant current discharge values.
3. Recommended to follow IEEE -485 Standard for Battery sizing (In terms of Aging Margin, Design Margin) for Optimal Performance & Life.
4. Considerable Voltage drop across cables, if any shall be considering during battery sizing.



CAUTION

- ⚠ Avoid short circuit
- ⚠ Don't charge in a sealed container



THE LONG LIFE UPS BATTERY



Performance

A clutch of design features ensures that AMARON QUANTA™ batteries perform predictably and reliably every time

- ✓ Proven AGM technology that ensures maintenance free characteristics
- ✓ A unique heavy duty corrosion-resistant alloy for positive grids to increase cyclic life in tropical
- ✓ Radgrid™ profile provides lower internal resistance and superior high-discharge performance
- ✓ Instacharge™ a patented paste recipe for excellent charge acceptance
- ✓ Low self-discharge rates for extended storage periods
- ✓ Design Float life of upto 10 years
- ✓ Clean and Sleek looks

Compliance

- ✓ JIS C 8702 Certified
- ✓ UL (UL-1989) & CE Certified
- ✓ Complies to IEC61056 & EUROBAT
- ✓ Complies to IS 16220
- ✓ Manufactured in ISO 9001, ISO 14001, ISO45001:2018 certified facilities

Applications

- ✓ Data Centers
- ✓ Banks & Financial Markets
- ✓ Network Operations Centers
- ✓ Industrial Process Control Facilities
- ✓ Safety, Surveillance & Security Systems
- ✓ Semiconductor Manufacturing
- ✓ Power Generation Plants
- ✓ Hospital & Testing laboratories

Discharge Characteristics

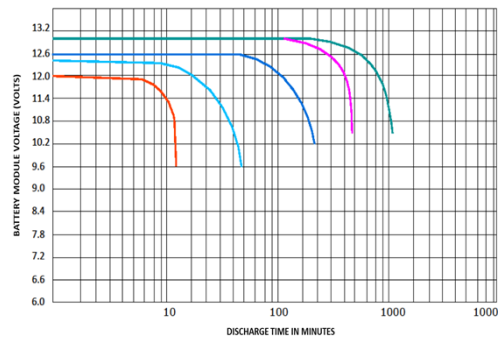

Temperature Effect on Capacity

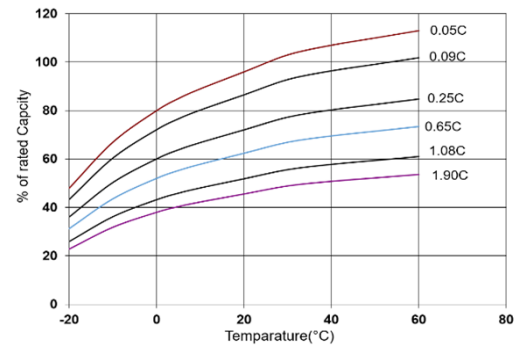

Shelf Life Characteristics

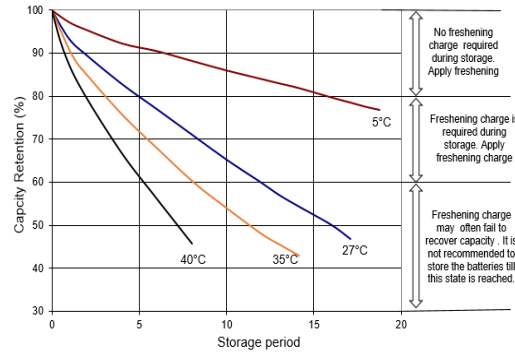

Float Service Life vs. Temperature

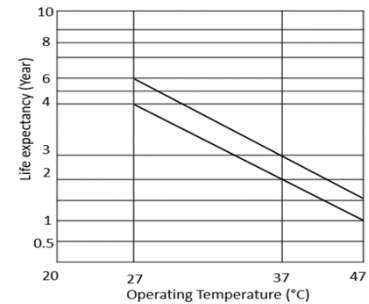

AMARA RAJA BATTERIES LIMITED

- **CORPORATE OPERATIONS OFFICE:**
Terminal A, 1-18/1/AMR/NR, Nanakramguda, Gachibowli, Hyderabad-500032, INDIA, [E-Mail: mkte@amararaja.com](mailto:mkte@amararaja.com)
www.amararajabatteries.com
- **REGISTERED OFFICE & Manufacturing Facility-1:**
UNIT-I, Karakambadi - 517520, Tirupati, Andhra Pradesh, INDIA, TEL: +91-877-2265000, FAX: +91-877-2285600
- **Manufacturing Facility-2**
UNIT-II, Nunegundlapalle, Bangarupalyam, Chittoor - 517416. Andhra Pradesh, INDIA



ARBL/AE/AQ/65Ah; May'2022; Rev-00